

4

3

2

1

B

B

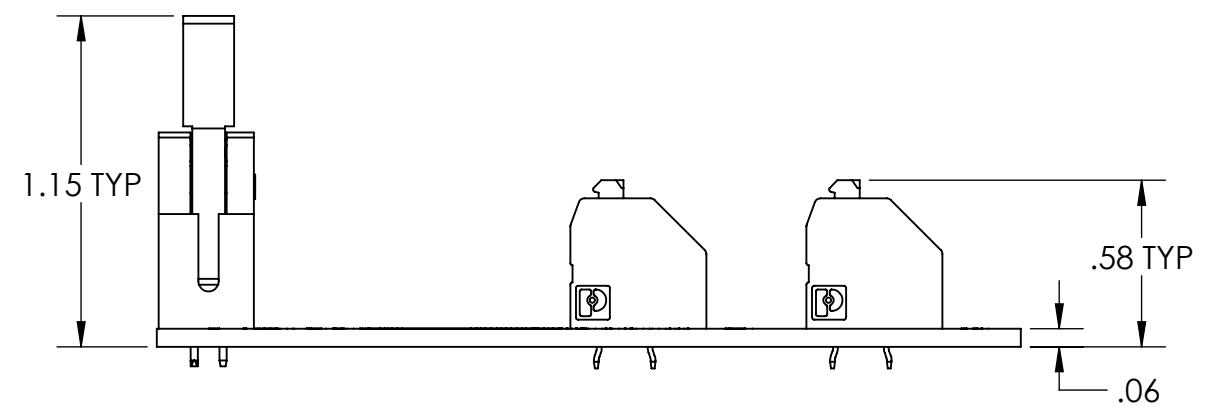
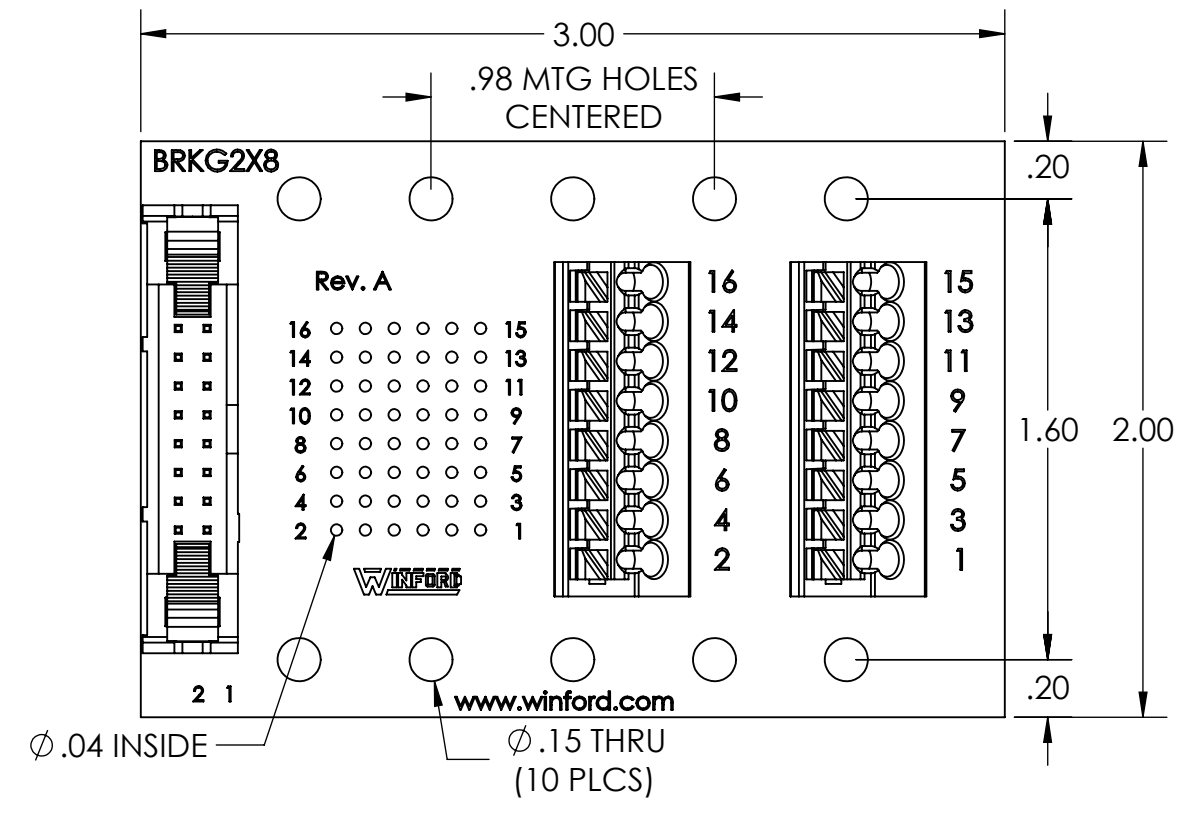
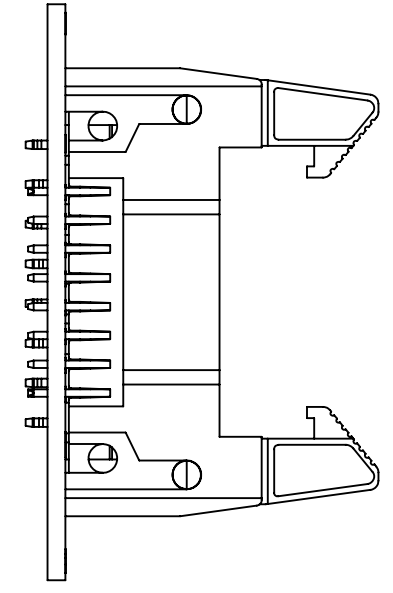

A

A

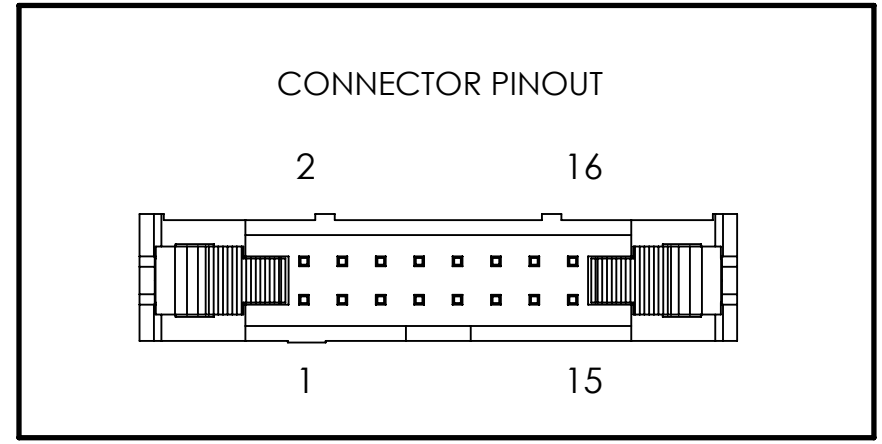

DIM: INCH	DATE: 02/08/2020	RoHS COMPLIANT: YES	DESCRIPTION:
 WINFORD ENGINEERING, LLC 4561 GARFIELD ROAD AUBURN, MI 48611			2x8 0.1" Header Breakout
www.winford.com		989-671-9721	PART NUMBER (S) BRKG2X8-L-N
			PART REVISION A

4

3

2

1