

4

3

2

1

B

B

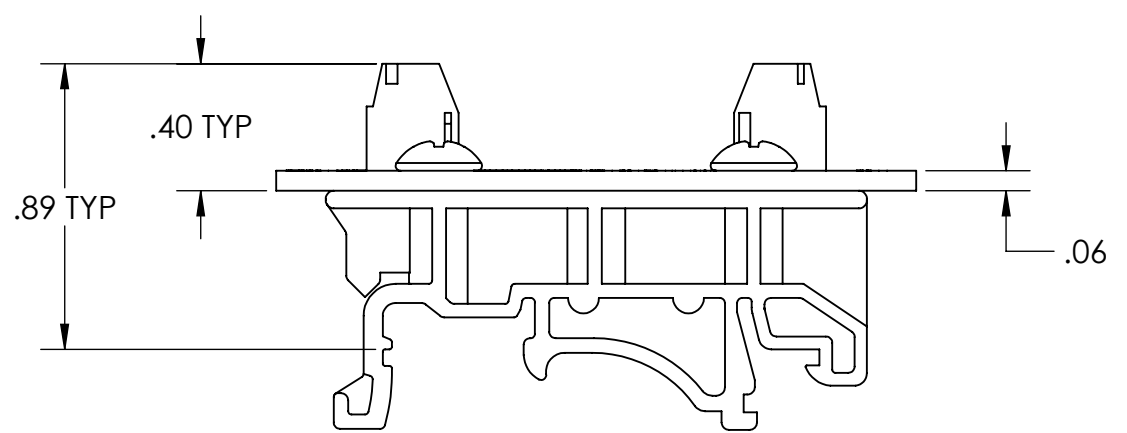
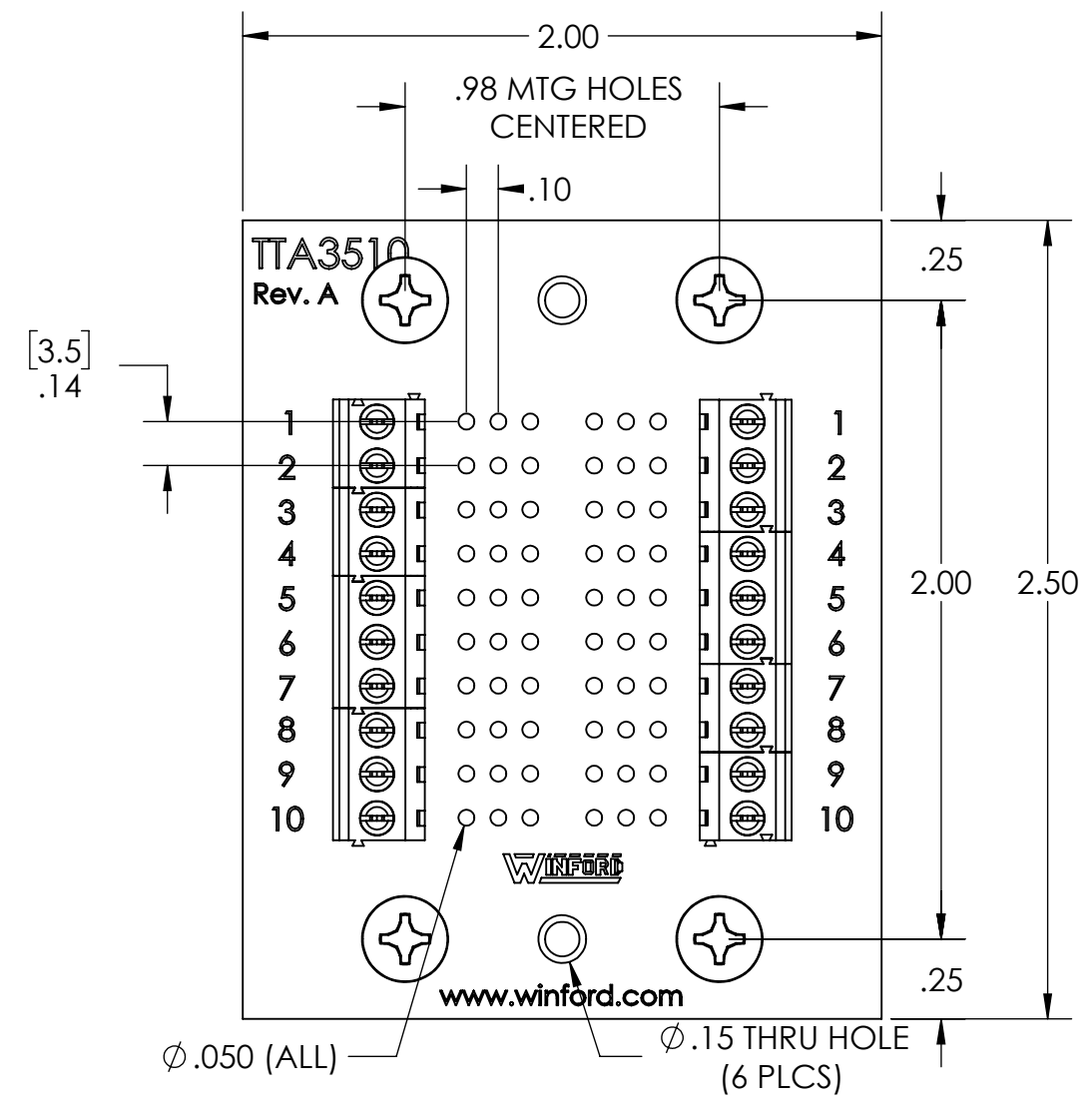
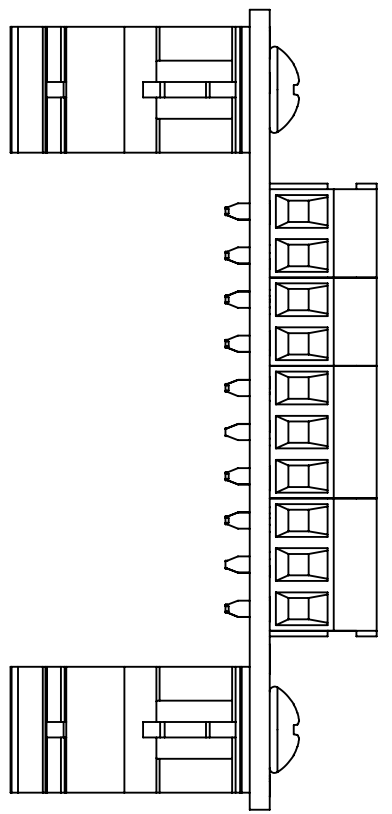

A

A

DIM: INCH	DATE: 11/18/2022	RoHS COMPLIANT: YES	DESCRIPTION:
 WINFORD ENGINEERING, LLC 4561 GARFIELD ROAD AUBURN, MI 48611			Screw Terminal Board, 10-Pos
www.winford.com		989-671-9721	PART NUMBER (S)
			TTA3510-DIN
			PART REVISION
			A

4

3

2

1